

**A5800**

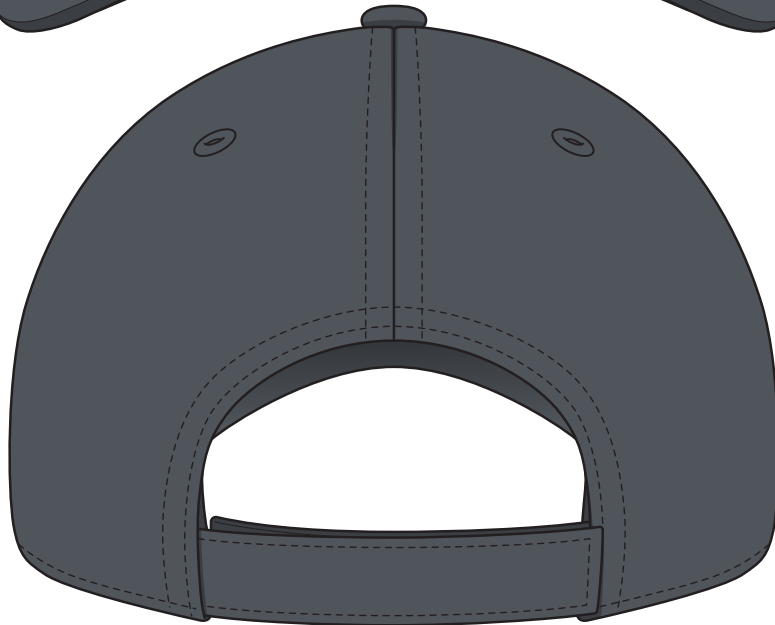

-----  
COLOUR

# A5800

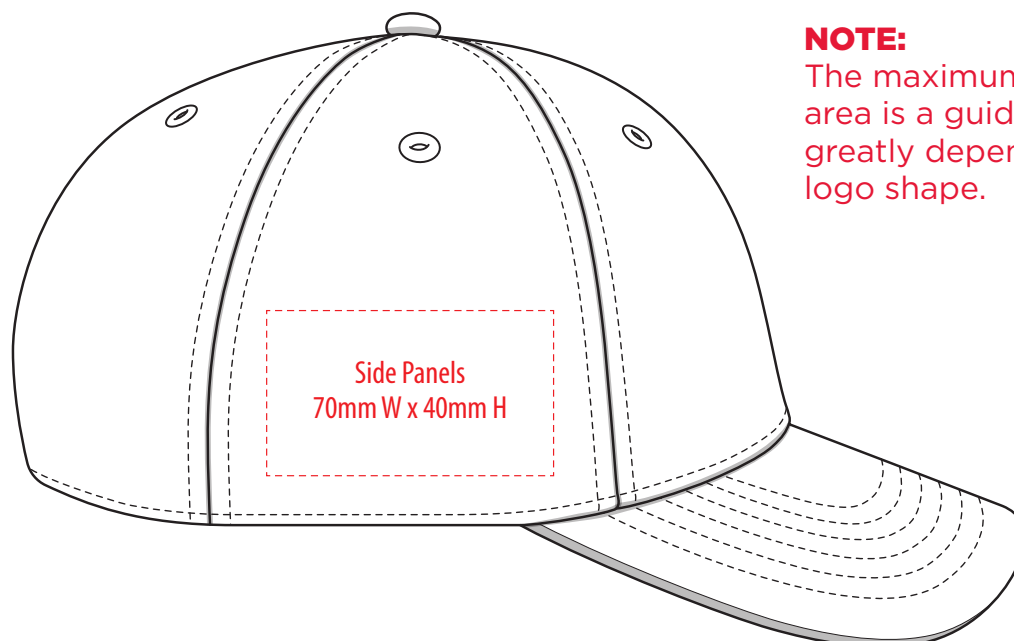
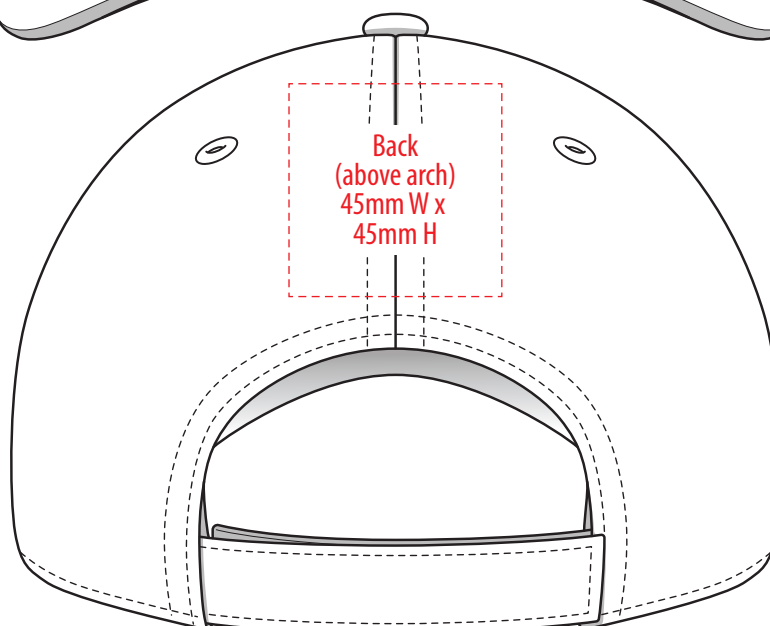
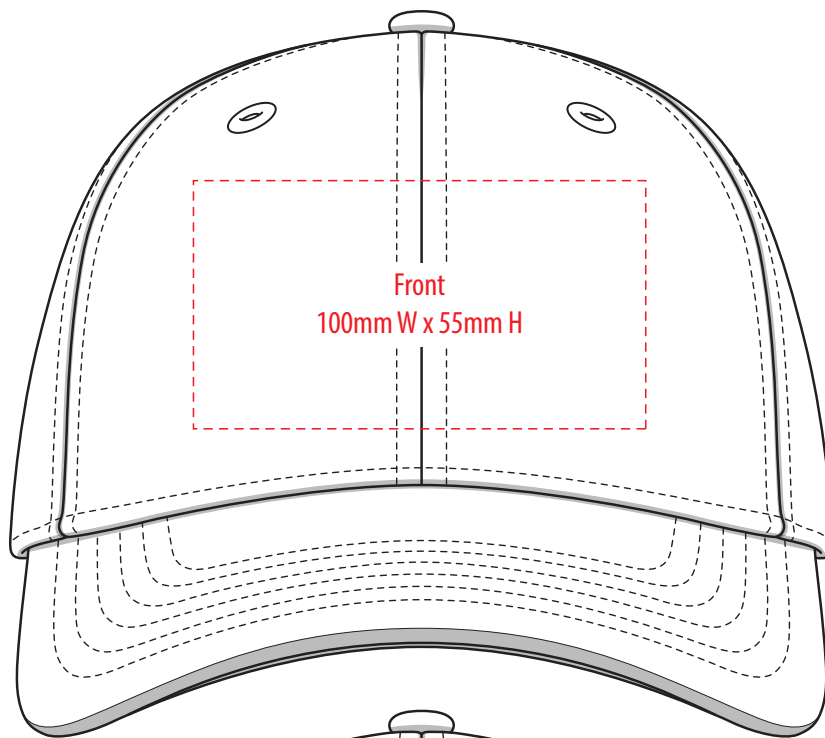

**NOTE:**

The maximum decoration area is a guide only and is greatly dependant on the logo shape.

-----  
SUPASUB/SUPAETCH/SUPAFLEX

# A5800

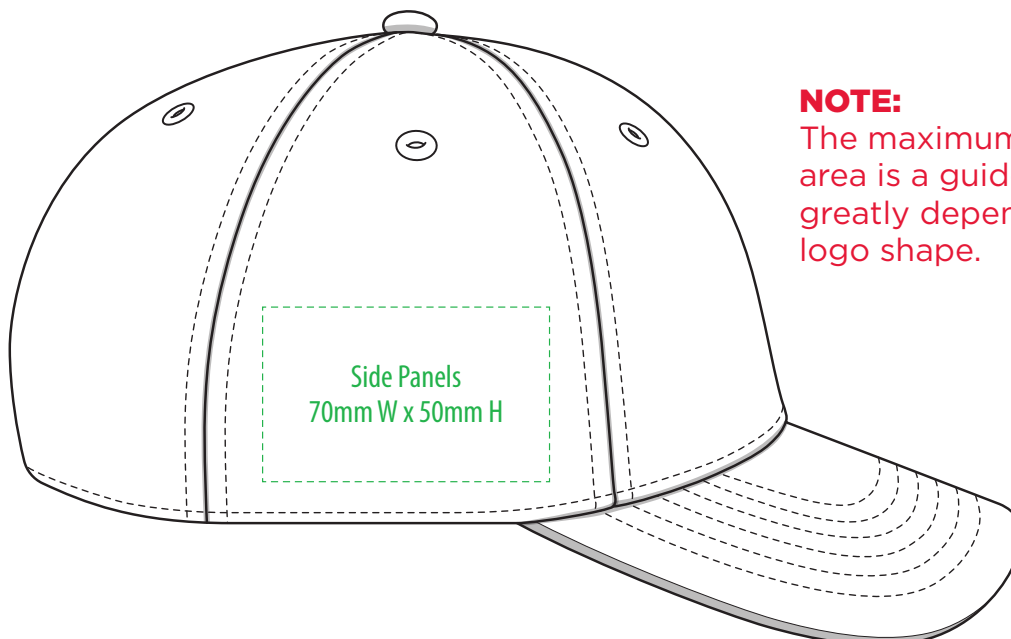
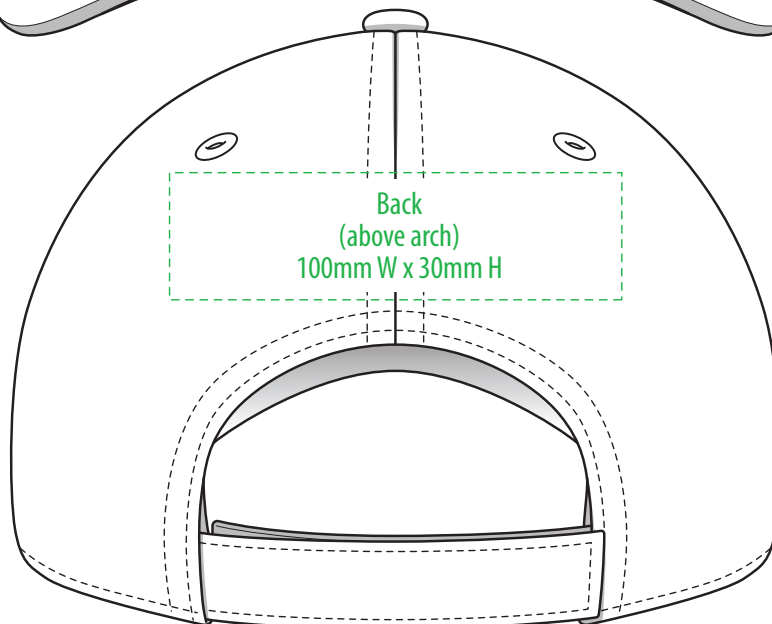
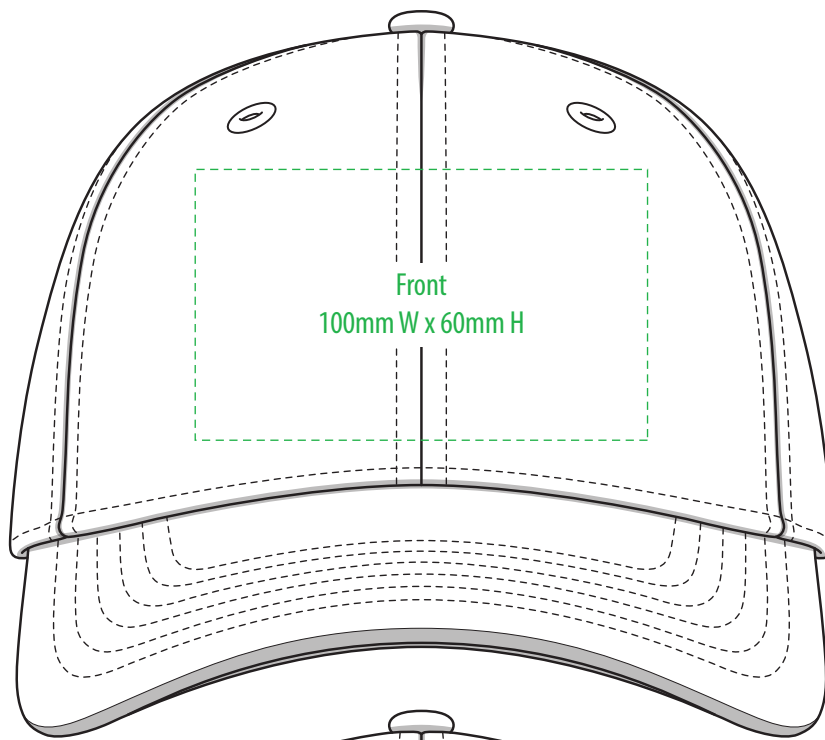

**NOTE:**

The maximum decoration area is a guide only and is greatly dependant on the logo shape.

-----  
SUPACOLOUR

# A5800

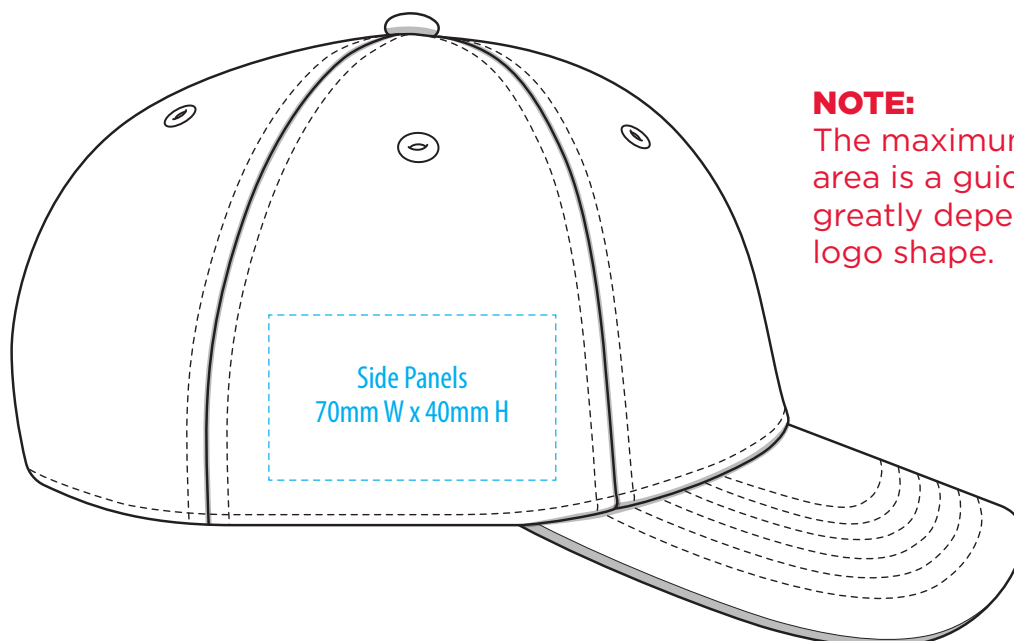
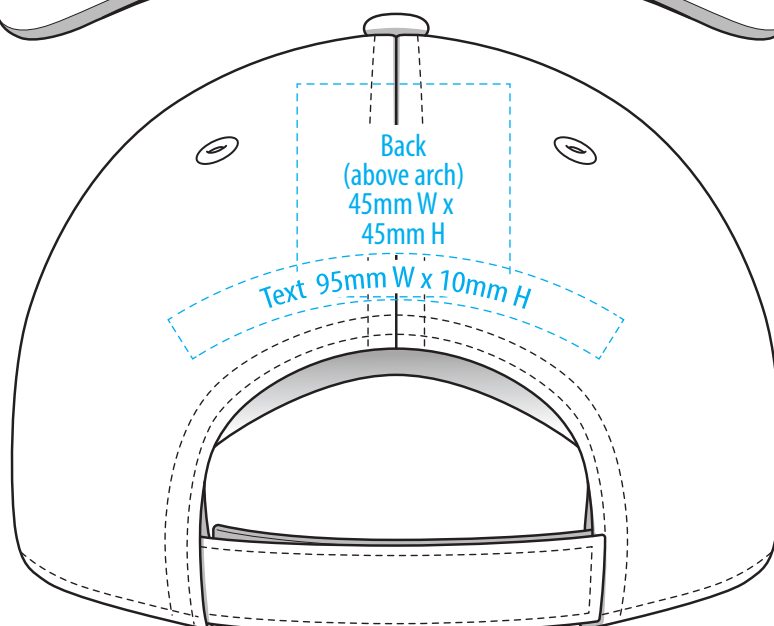
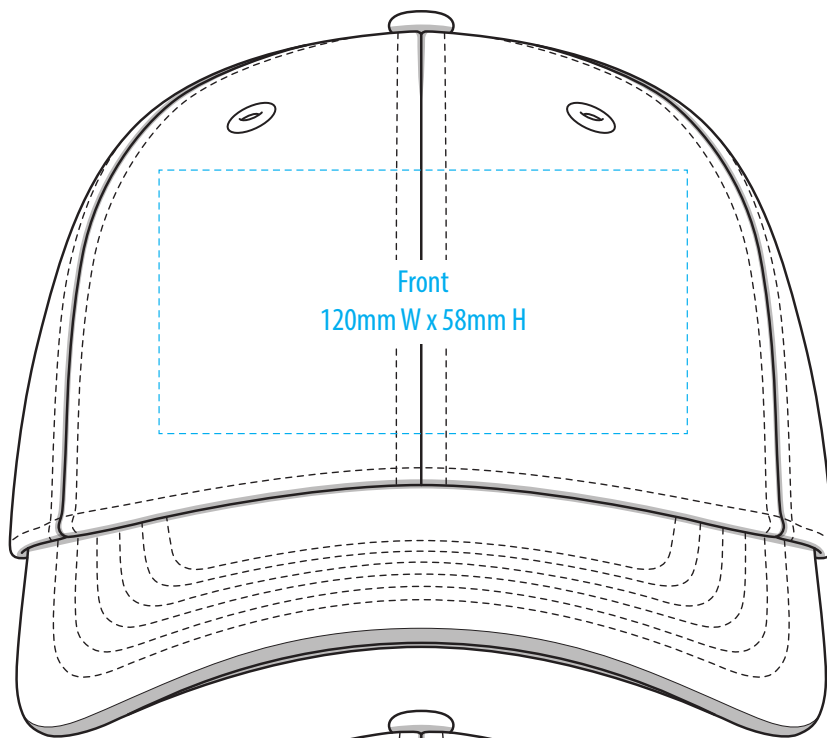

**NOTE:**  
The maximum decoration area is a guide only and is greatly dependant on the logo shape.

-----  
EMBROIDERY