

10% of Actual Size
Screen Print

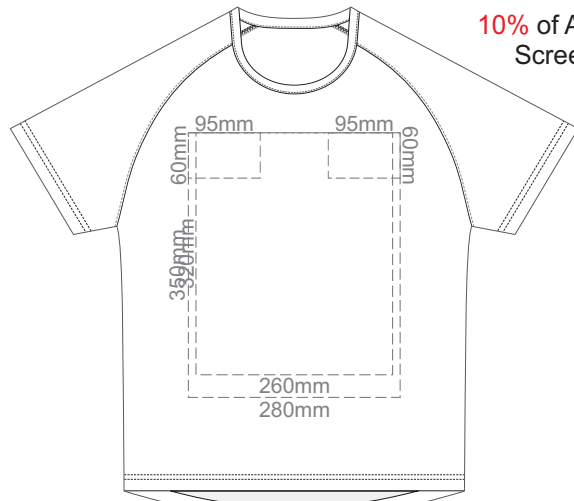

10% of Actual Size
Screen Print

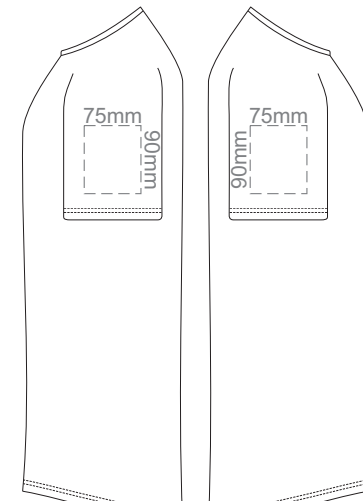
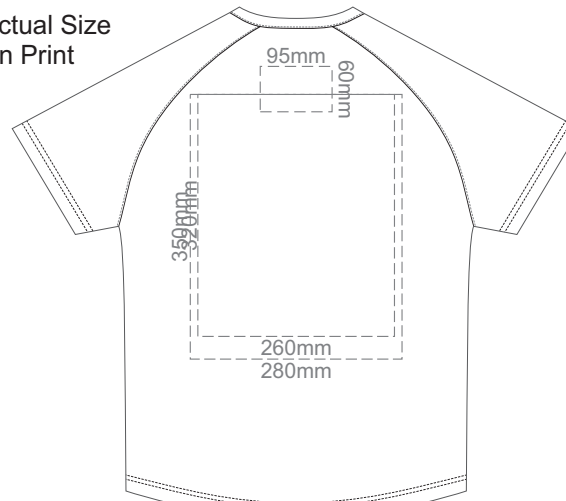

FRONT MEN'S EXTRA SMALL

BACK MEN'S EXTRA SMALL

MEN'S XS LEFT SLEEVE

MEN'S XS RIGHT SLEEVE

10% of Actual Size
Colourflex Transfer
Faux Embroidery

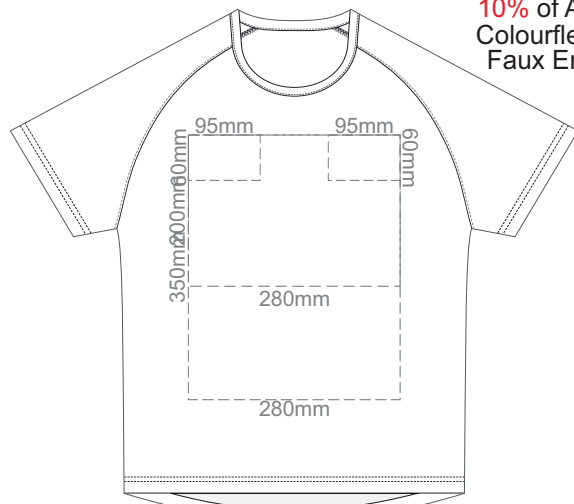

10% of Actual Size
Colourflex Transfer
Faux Embroidery

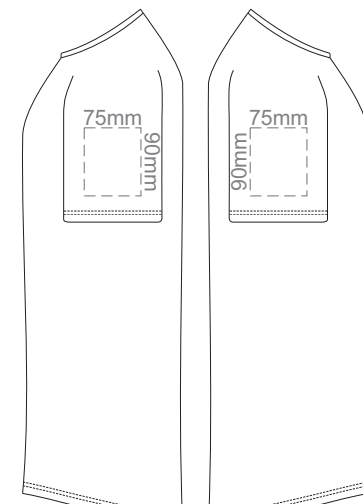
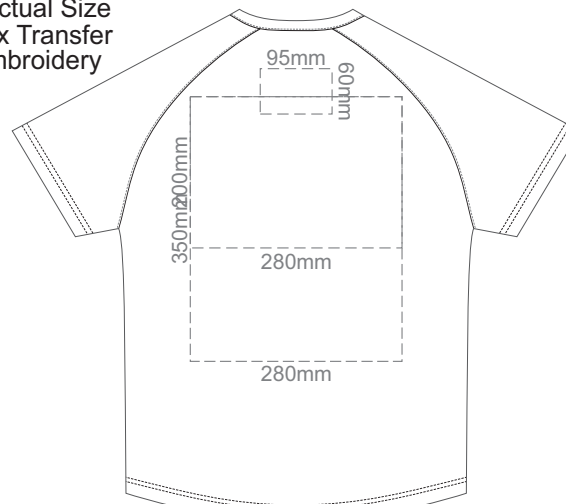

FRONT MEN'S EXTRA SMALL
Print area 280x200mm can be rotated to best suit.

BACK MEN'S EXTRA SMALL
Print area 280x200mm can be rotated to best suit.

MEN'S XS LEFT SLEEVE

MEN'S XS RIGHT SLEEVE



10% of Actual Size
Embroidery

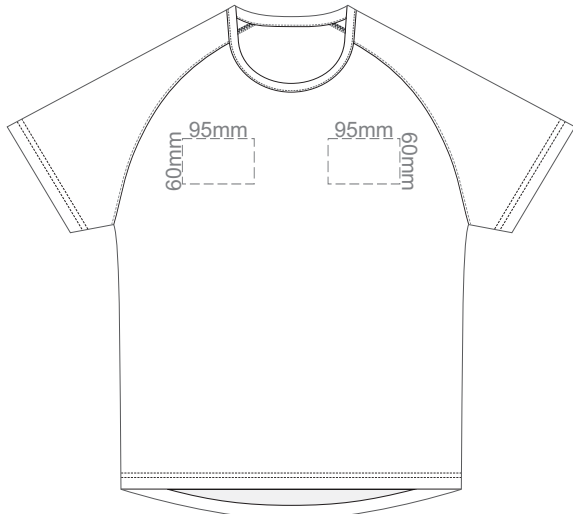

FRONT MEN'S EXTRA SMALL

10% of Actual Size
Embroidery

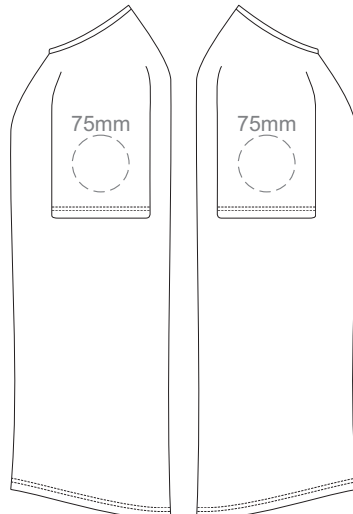

MEN'S XS LEFT SLEEVE

MEN'S XS RIGHT SLEEVE

MEN'S EXTRA SMALL



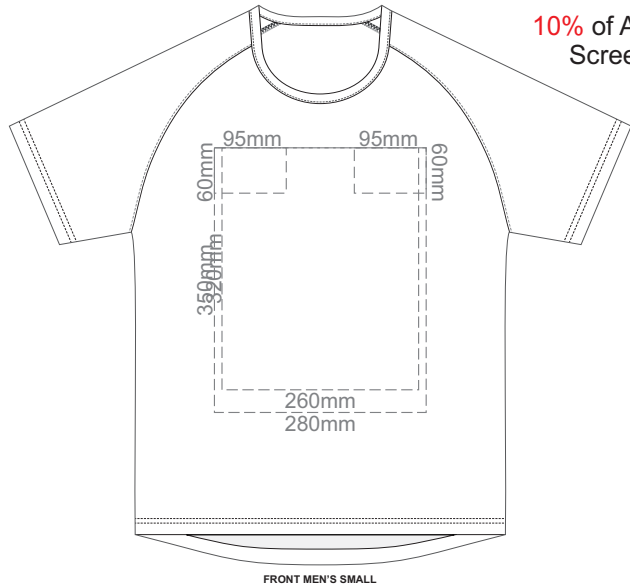

10% of Actual Size
Screen Print

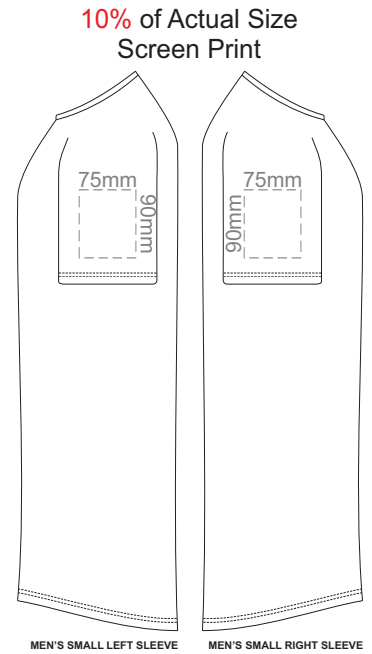
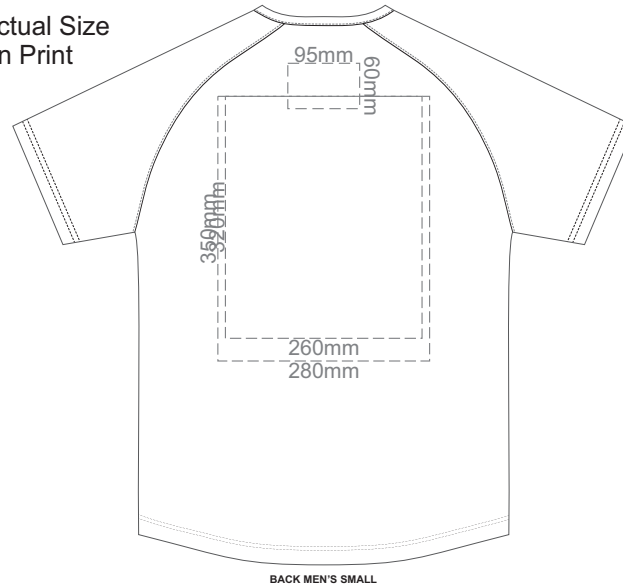

FRONT MEN'S SMALL

BACK MEN'S SMALL

MEN'S SMALL LEFT SLEEVE

MEN'S SMALL RIGHT SLEEVE

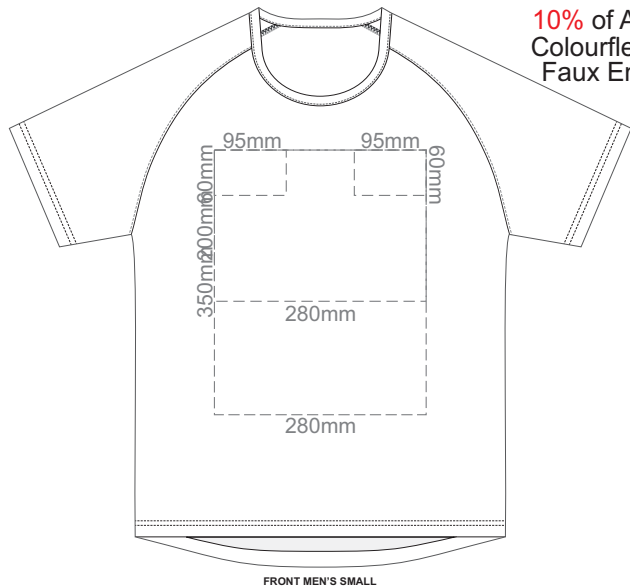

10% of Actual Size
Colourflex Transfer
Faux Embroidery

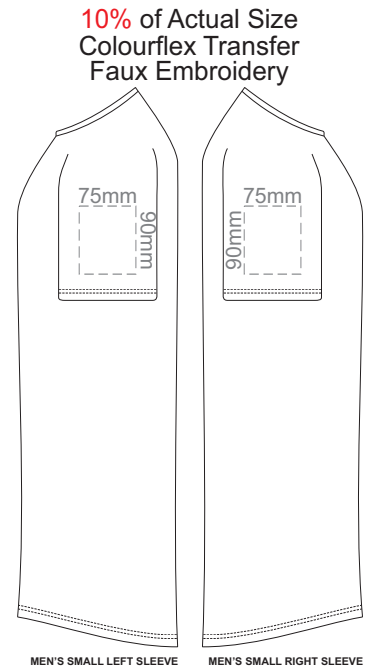
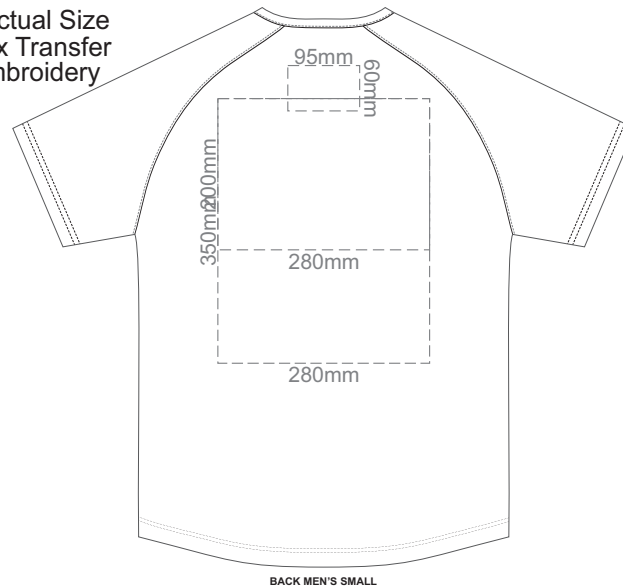

FRONT MEN'S SMALL

BACK MEN'S SMALL

MEN'S SMALL LEFT SLEEVE

MEN'S SMALL RIGHT SLEEVE

Print area 280x200mm can be rotated to best suit.

Print area 280x200mm can be rotated to best suit.



10% of Actual Size
Embroidery

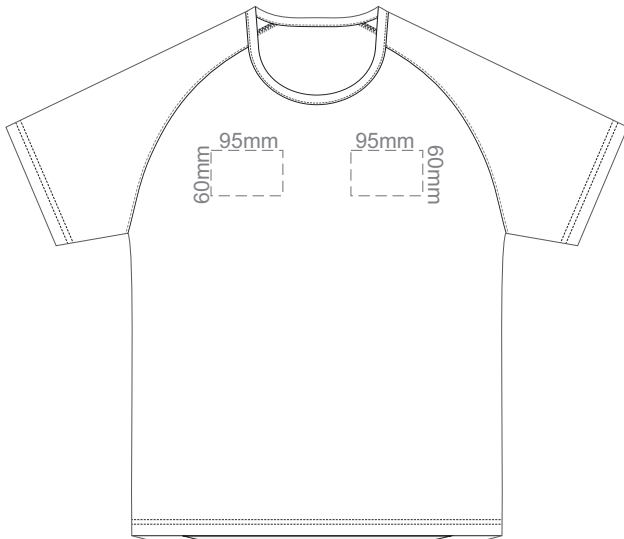

FRONT MEN'S SMALL

10% of Actual Size
Embroidery

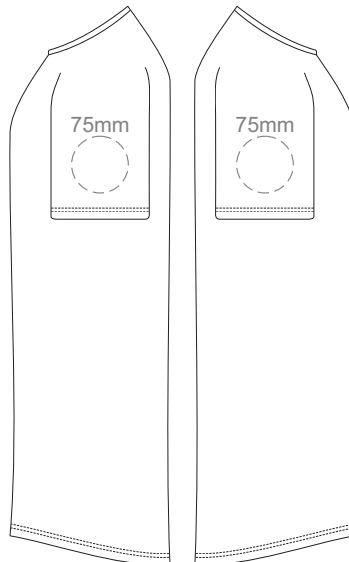

MEN'S SMALL LEFT SLEEVE

MEN'S SMALL RIGHT SLEEVE

MEN'S SMALL



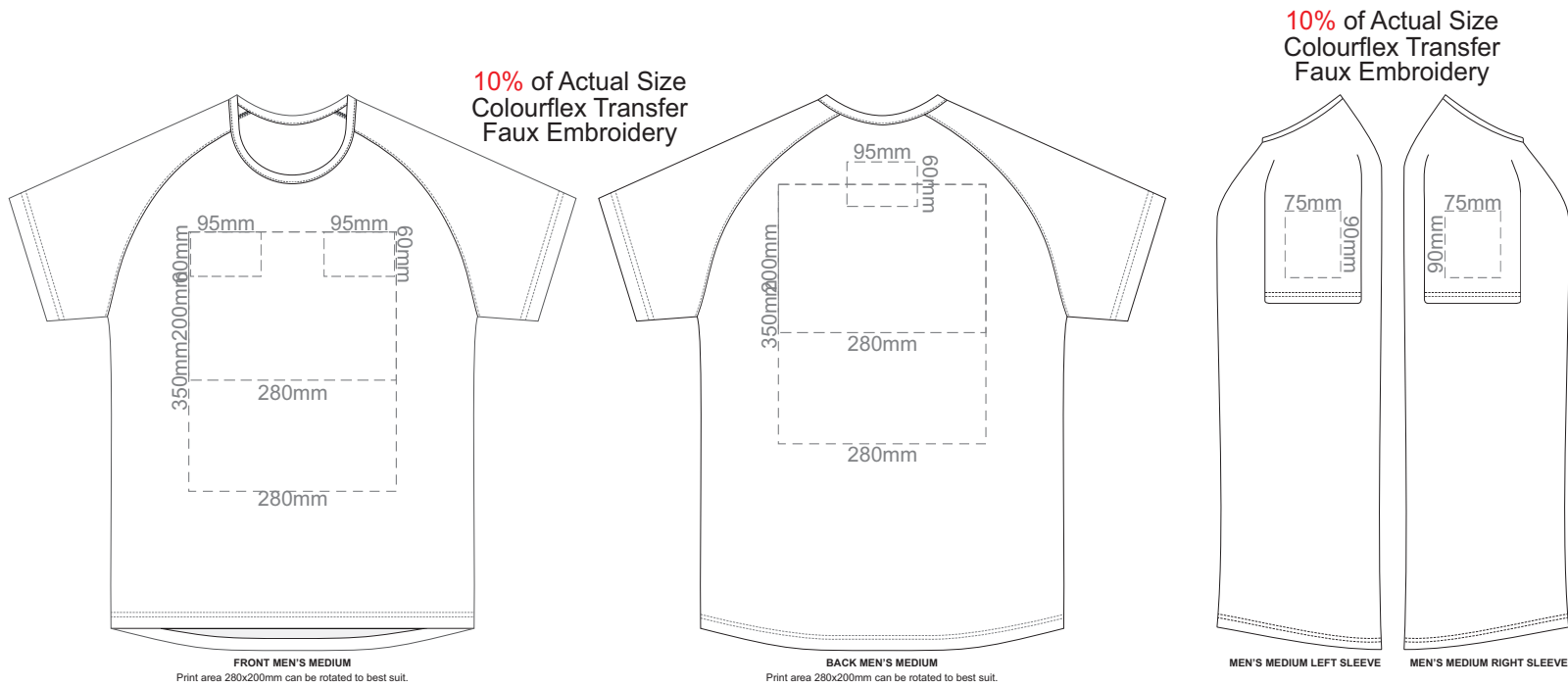
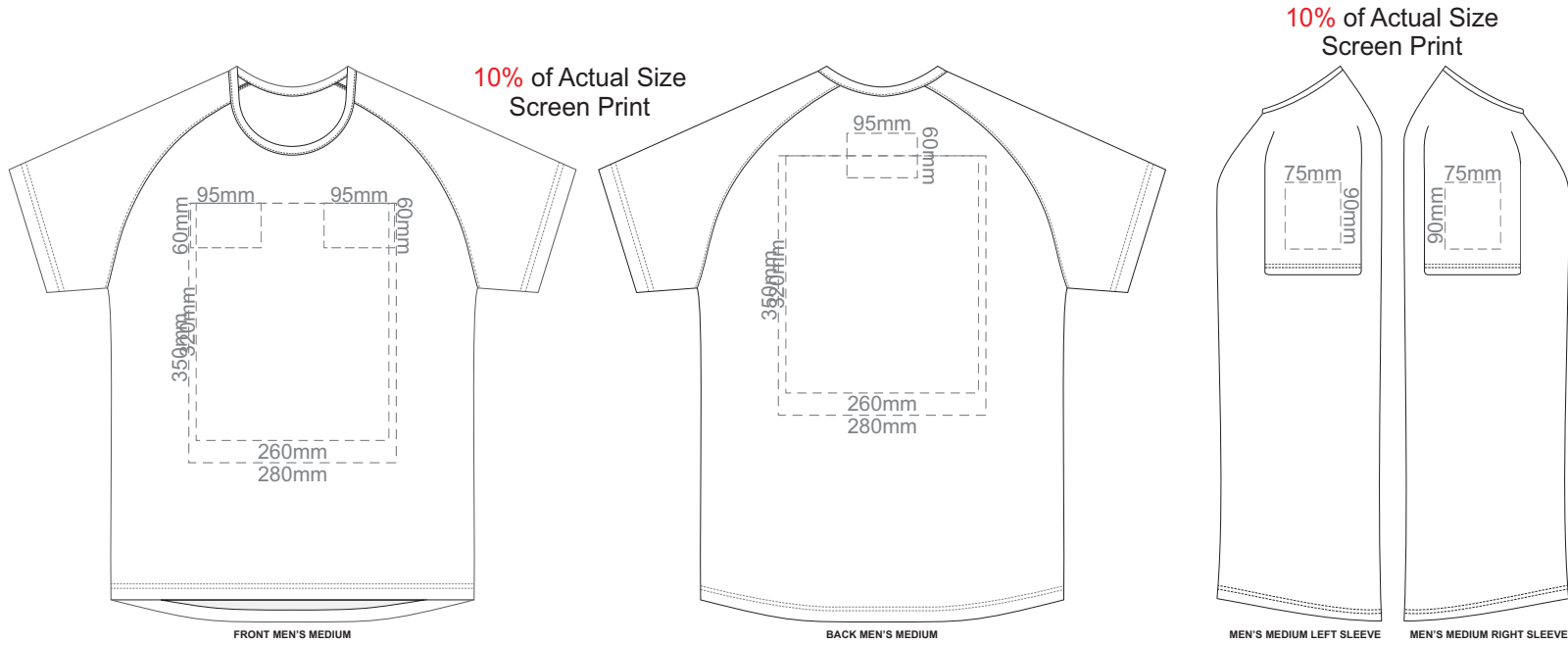

Print area 280x200mm can be rotated to best suit.

Print area 280x200mm can be rotated to best suit.



10% of Actual Size
Embroidery

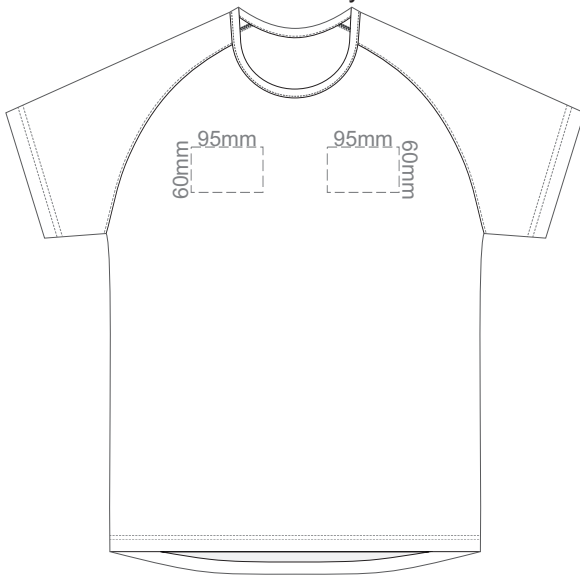

FRONT MEN'S MEDIUM

10% of Actual Size
Embroidery

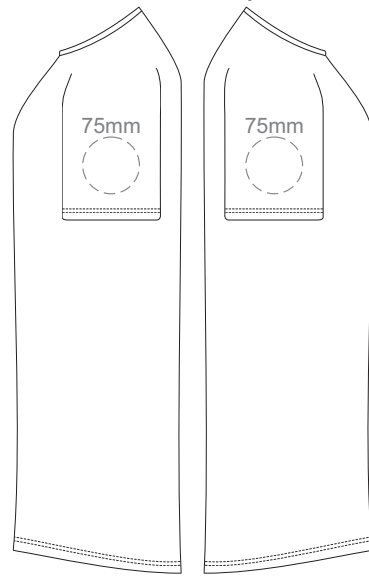

MEN'S MEDIUM LEFT SLEEVE

MEN'S MEDIUM RIGHT SLEEVE

MEN'S MEDIUM



10% of Actual Size
Screen Print

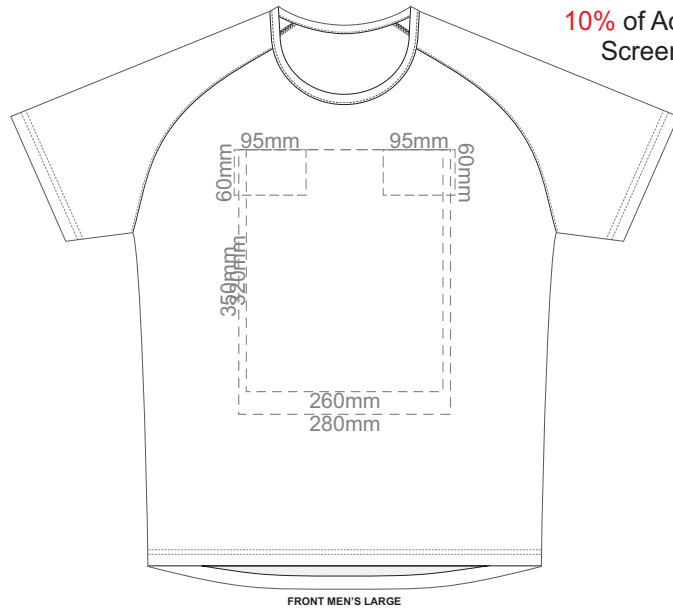

10% of Actual Size
Screen Print

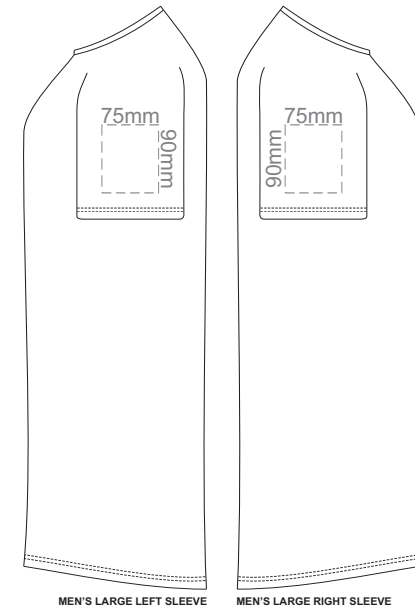
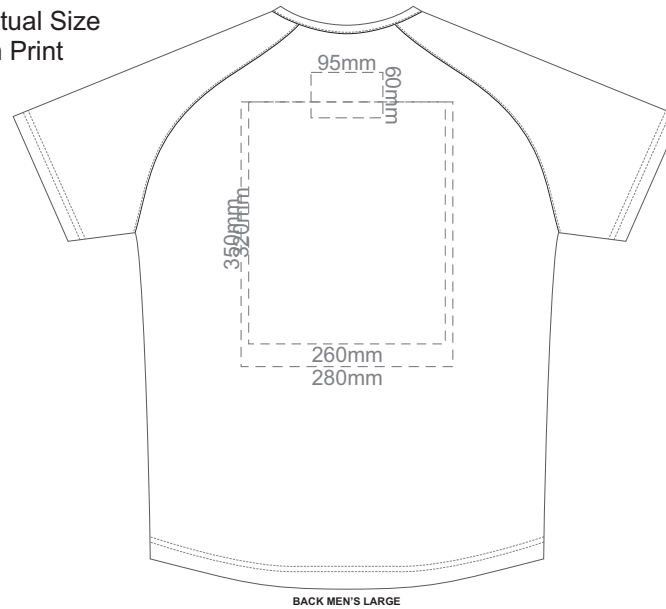

10% of Actual Size
Colourflex Transfer
Faux Embroidery

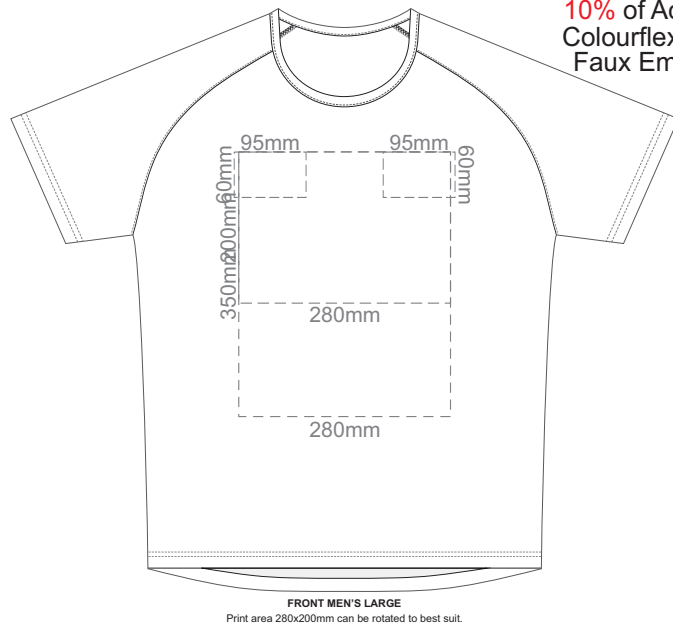

10% of Actual Size
Colourflex Transfer
Faux Embroidery

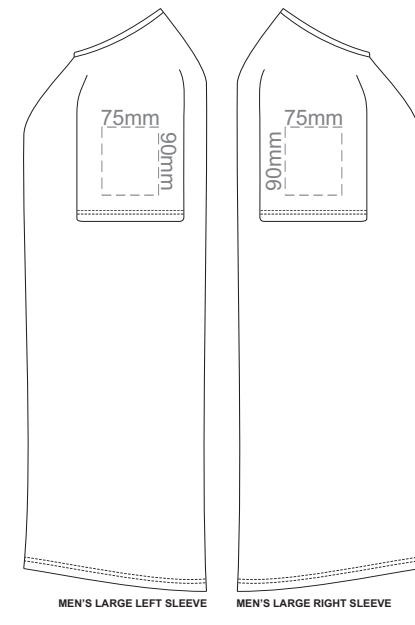
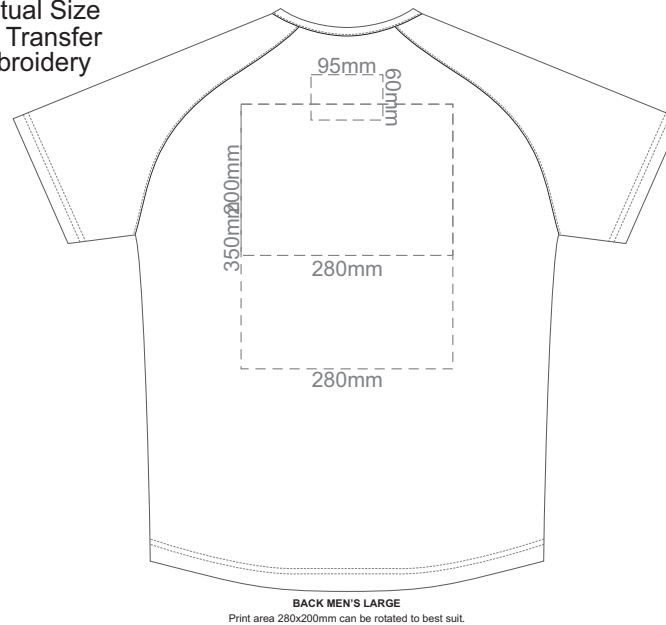

10% of Actual Size
Embroidery

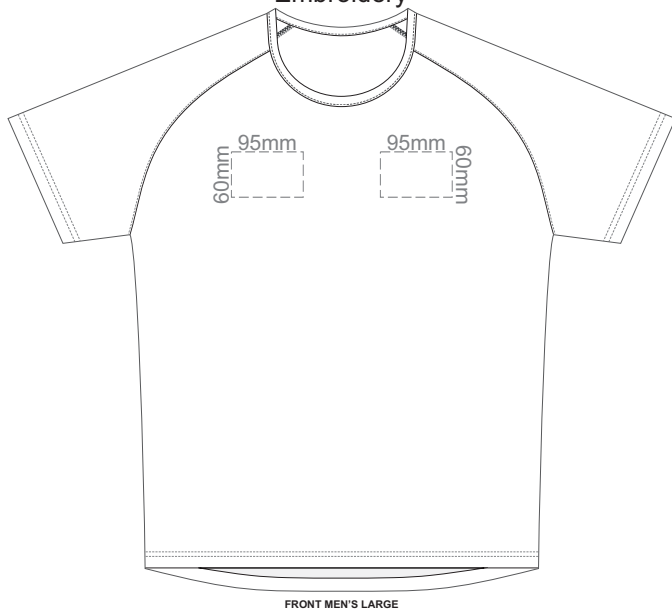

FRONT MEN'S LARGE

10% of Actual Size
Embroidery

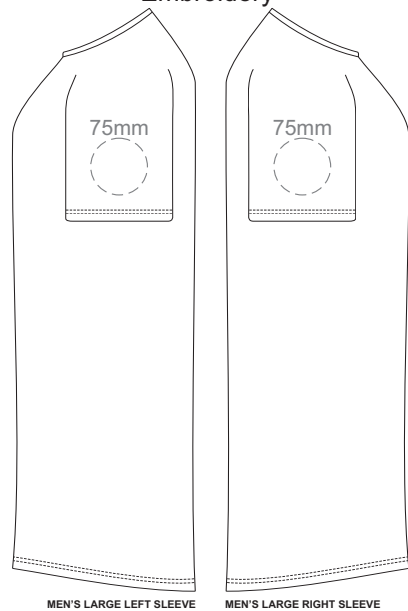

MEN'S LARGE LEFT SLEEVE

MEN'S LARGE RIGHT SLEEVE

MEN'S LARGE



10% of Actual Size
Screen Print

10% of Actual Size
Screen Print

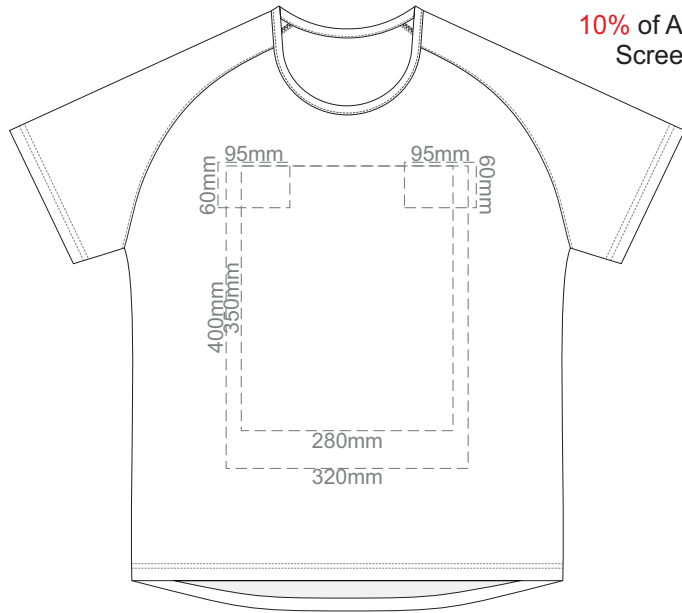

FRONT MEN'S XL

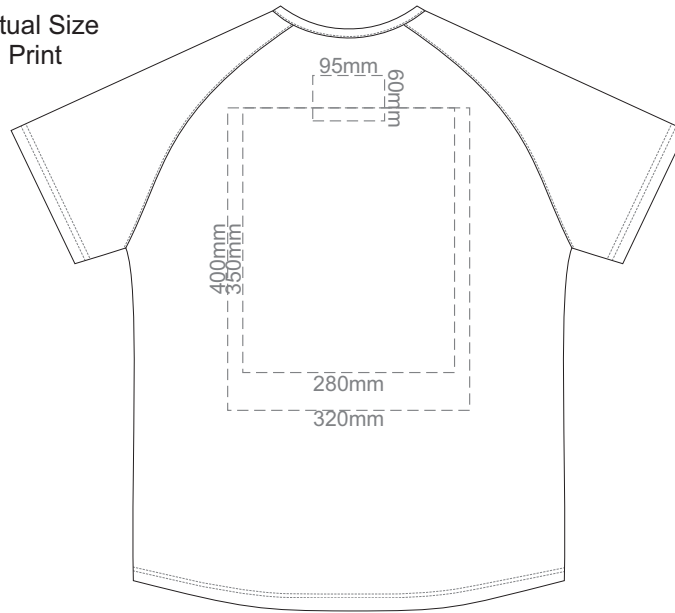

BACK MEN'S XL

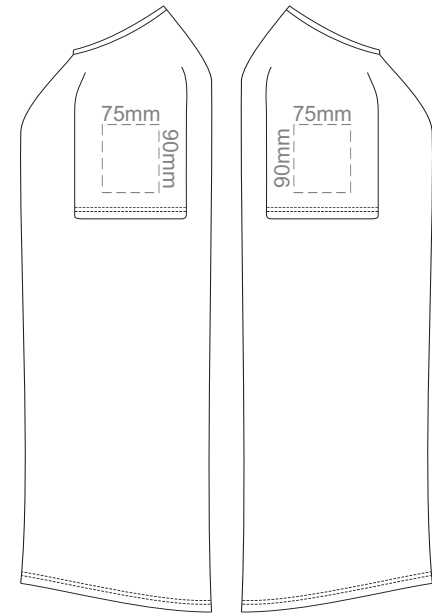

MEN'S XL LEFT SLEEVE

MEN'S XL RIGHT SLEEVE

10% of Actual Size
Colourflex Transfer
Faux Embroidery

10% of Actual Size
Colourflex Transfer
Faux Embroidery

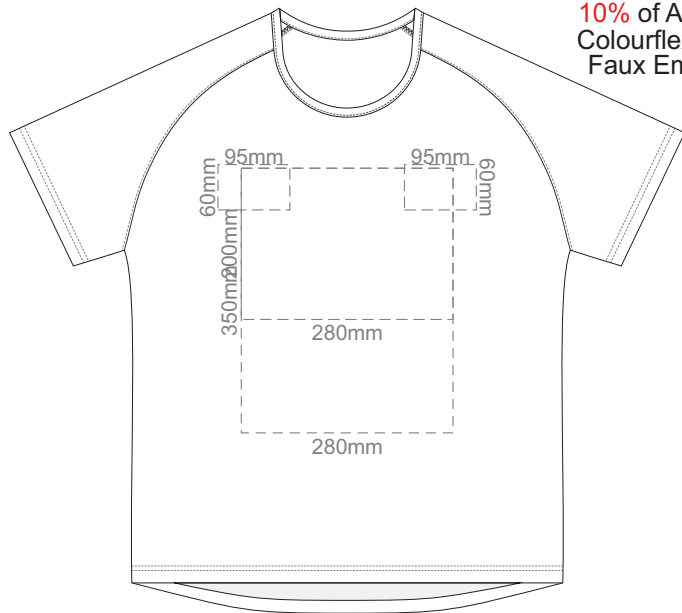

FRONT MEN'S XL

Print area 280x200mm can be rotated to best suit.

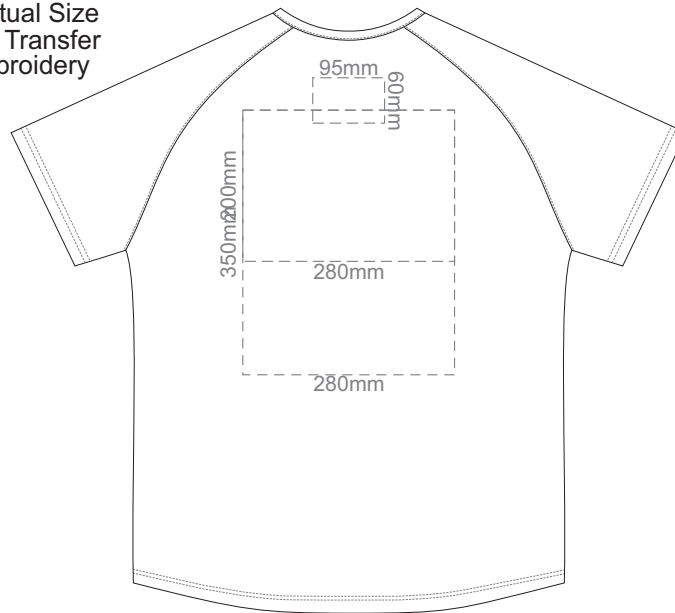

BACK MEN'S XL

Print area 280x200mm can be rotated to best suit.

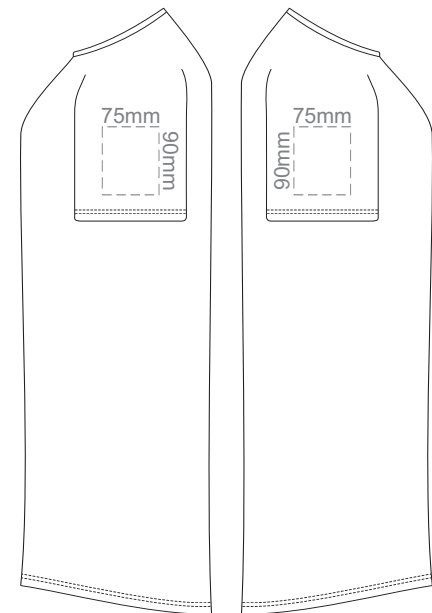

MEN'S XL LEFT SLEEVE

MEN'S XL RIGHT SLEEVE



10% of Actual Size
Embroidery

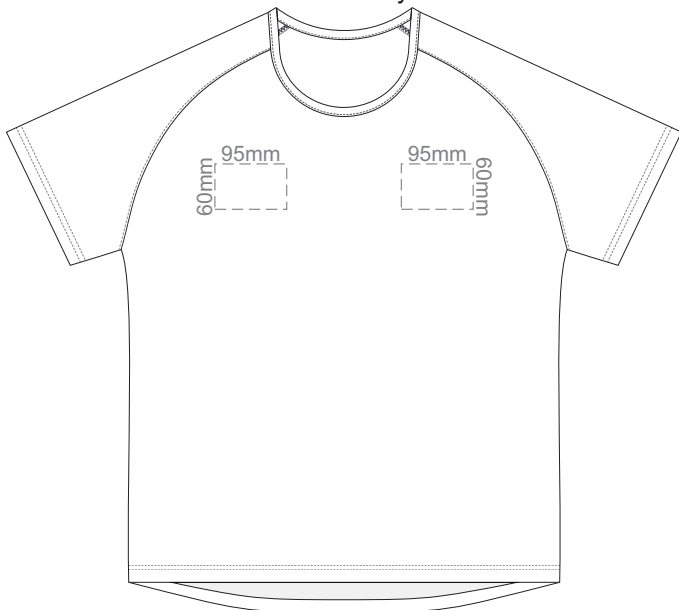

FRONT MEN'S XL

10% of Actual Size
Embroidery

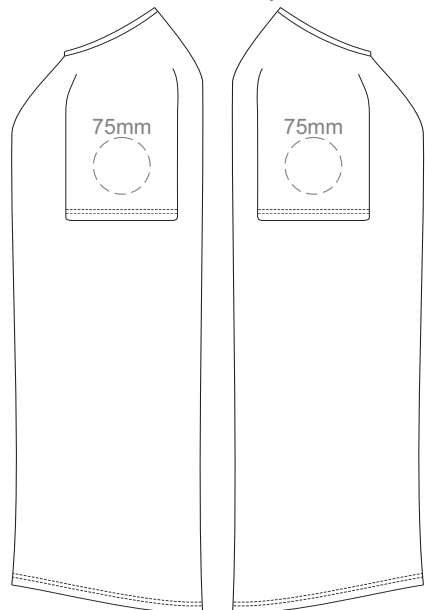

MEN'S XL LEFT SLEEVE

MEN'S XL RIGHT SLEEVE

MEN'S XL



10% of Actual Size
Screen Print

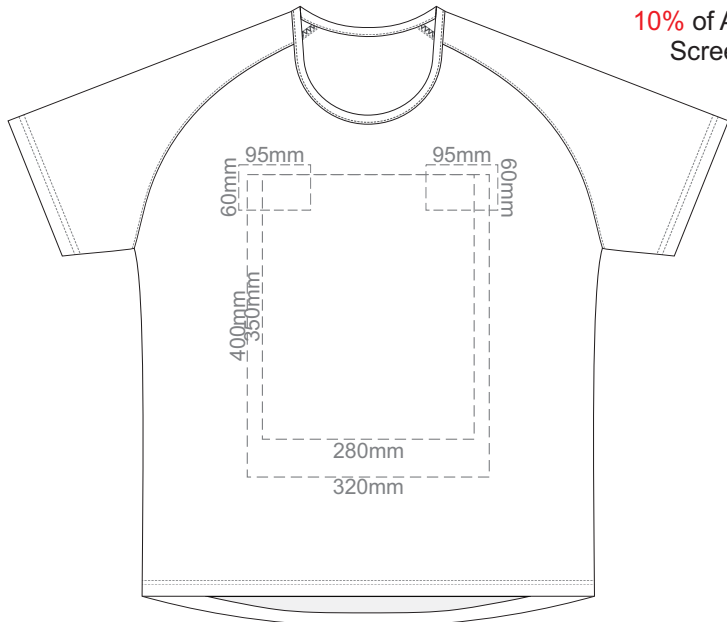

FRONT MEN'S 2XL

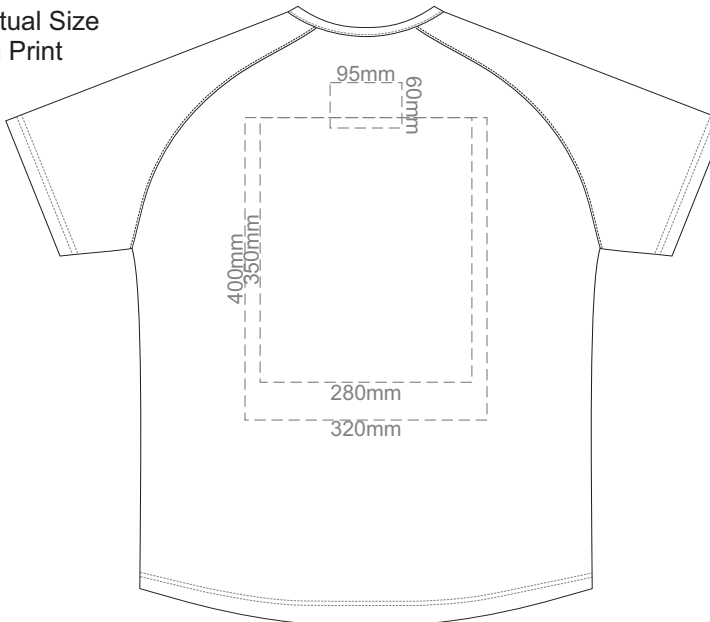

BACK MEN'S 2XL

10% of Actual Size
Screen Print

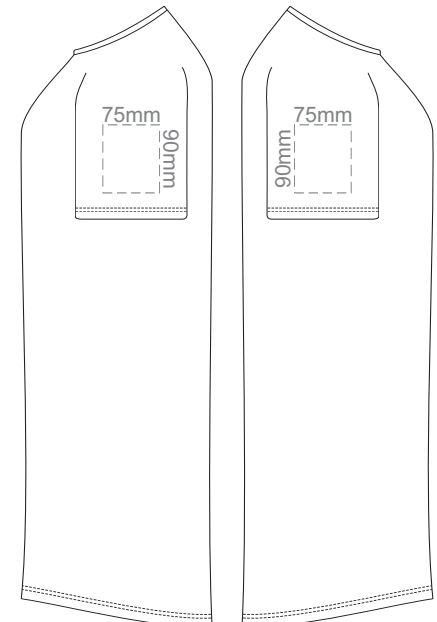

MEN'S 2XL LEFT SLEEVE

MEN'S 2XL RIGHT SLEEVE

10% of Actual Size
Colourflex Transfer
Faux Embroidery

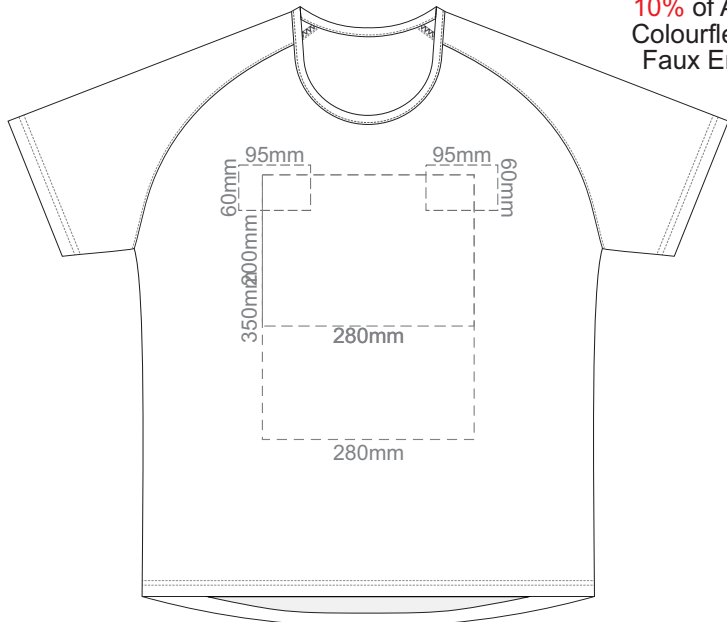

FRONT MEN'S 2XL

Print area 280x200mm can be rotated to best suit.

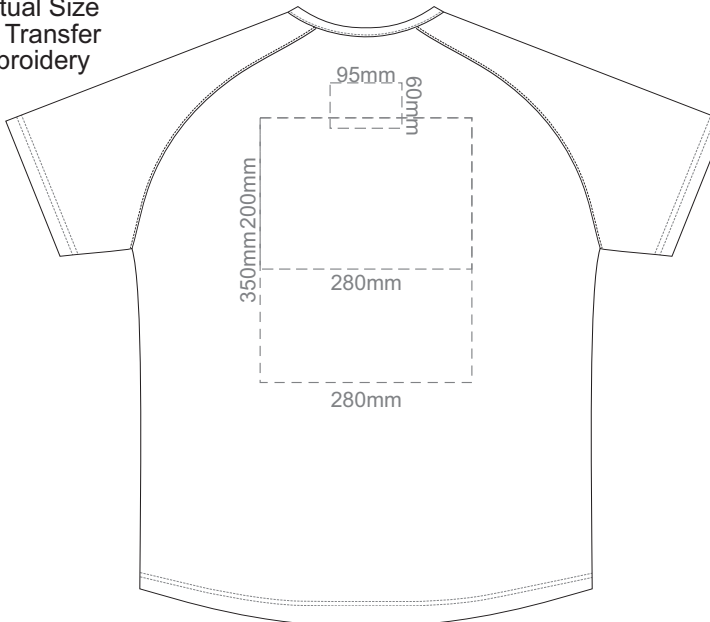

BACK MEN'S 2XL

Print area 280x200mm can be rotated to best suit.

10% of Actual Size
Colourflex Transfer
Faux Embroidery

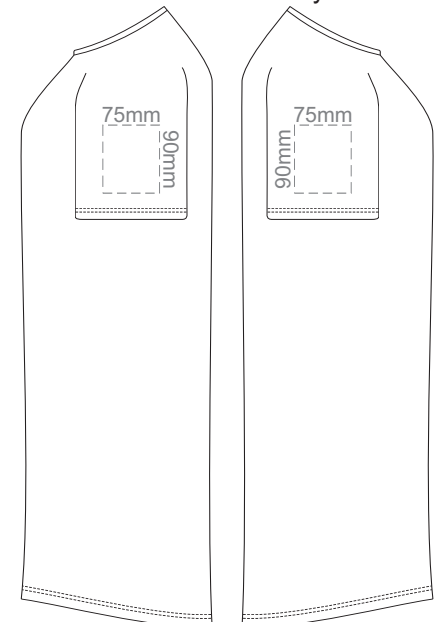

MEN'S 2XL LEFT SLEEVE

MEN'S 2XL RIGHT SLEEVE



10% of Actual Size
Embroidery

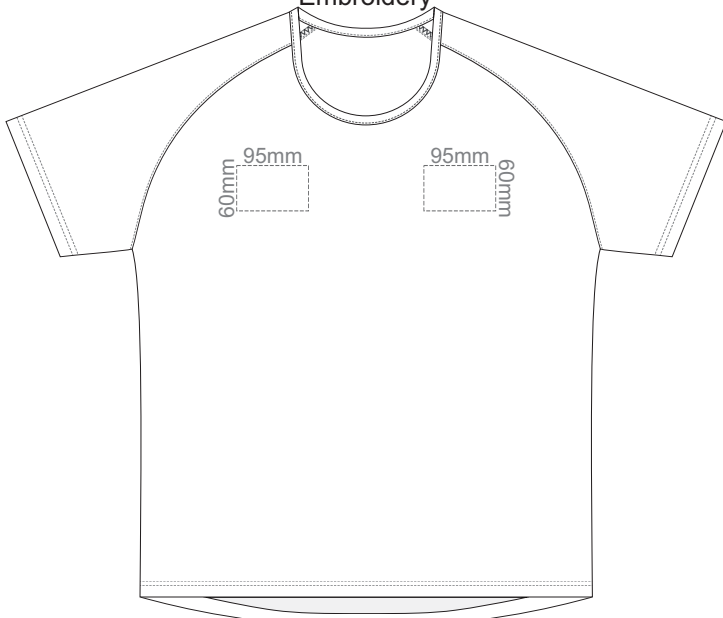

FRONT MEN'S 2XL

10% of Actual Size
Embroidery

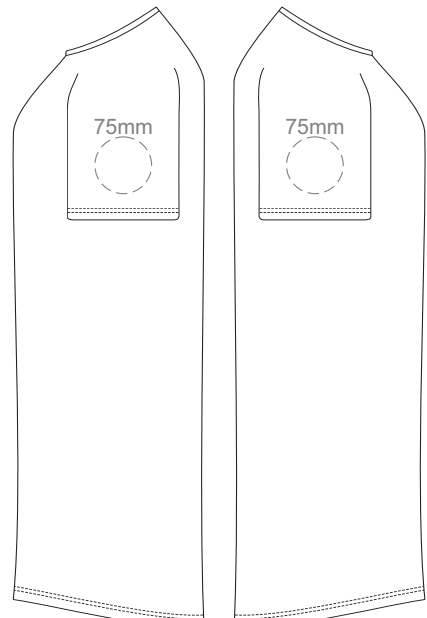

MEN'S 2XL LEFT SLEEVE

MEN'S 2XL RIGHT SLEEVE

MEN'S 2XL



10% of Actual Size
Screen Print

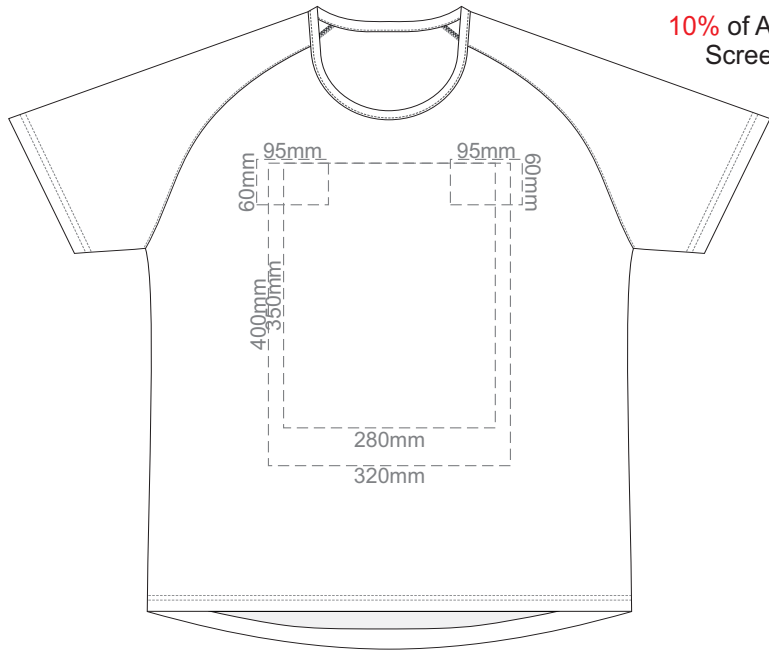

10% of Actual Size
Screen Print

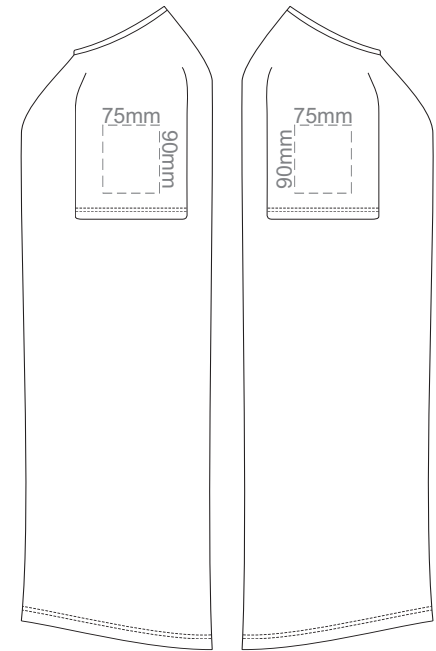
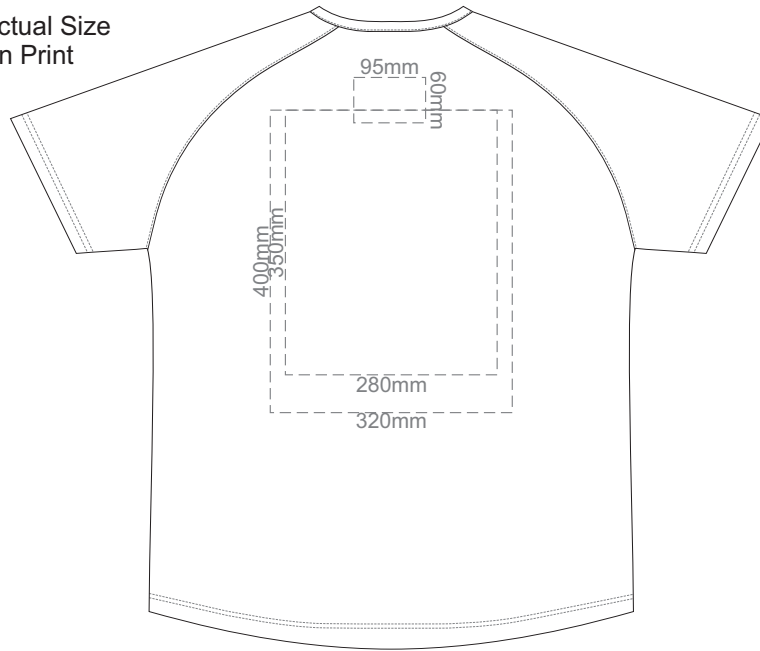

FRONT MEN'S 3XL

BACK MEN'S 3XL

MEN'S 3XL LEFT SLEEVE

MEN'S 3XL RIGHT SLEEVE

10% of Actual Size
Colourflex Transfer
Faux Embroidery

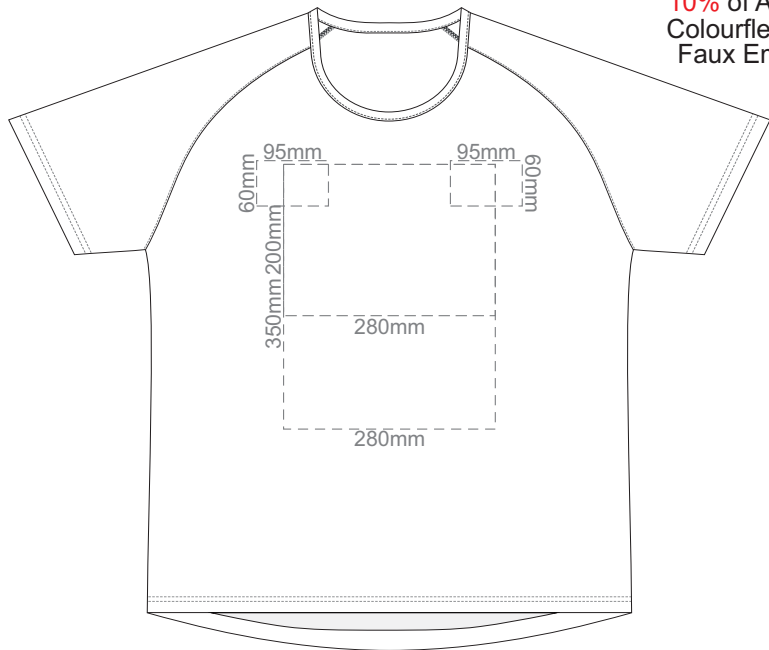

10% of Actual Size
Colourflex Transfer
Faux Embroidery

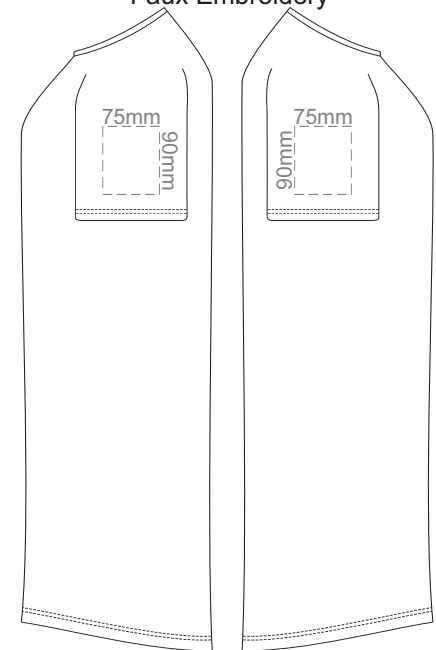
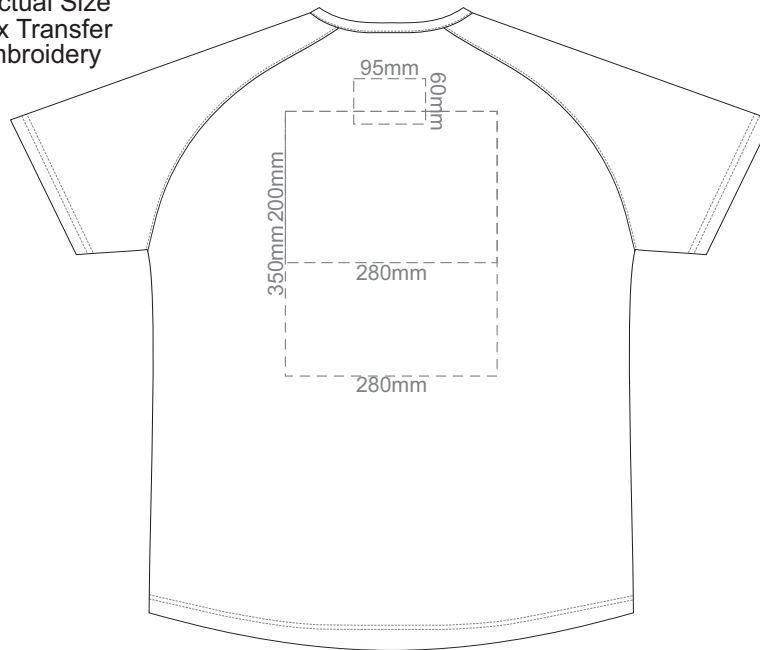

FRONT MEN'S 3XL

BACK MEN'S 3XL

MEN'S 3XL LEFT SLEEVE

MEN'S 3XL RIGHT SLEEVE

Print area 280x200mm can be rotated to best suit.

Print area 280x200mm can be rotated to best suit.



10% of Actual Size
Embroidery

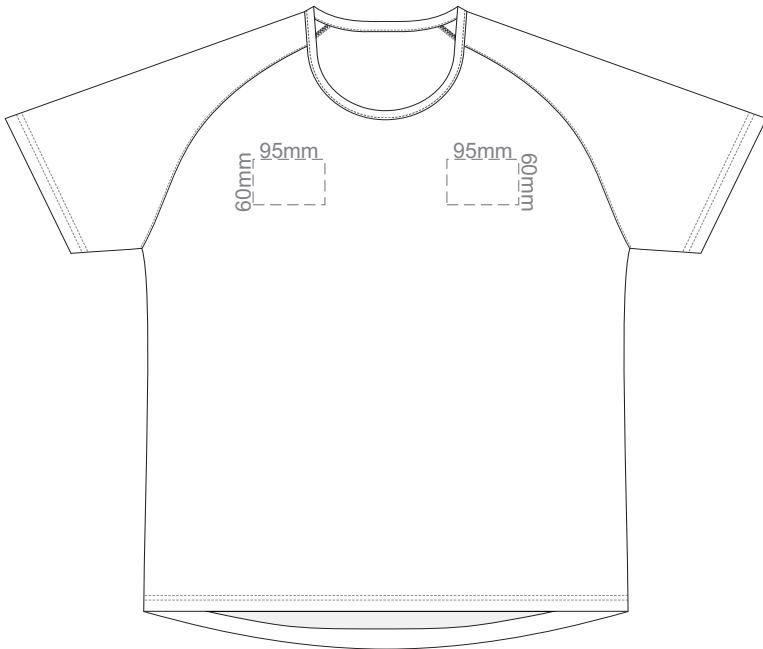

FRONT MEN'S 3XL

10% of Actual Size
Embroidery

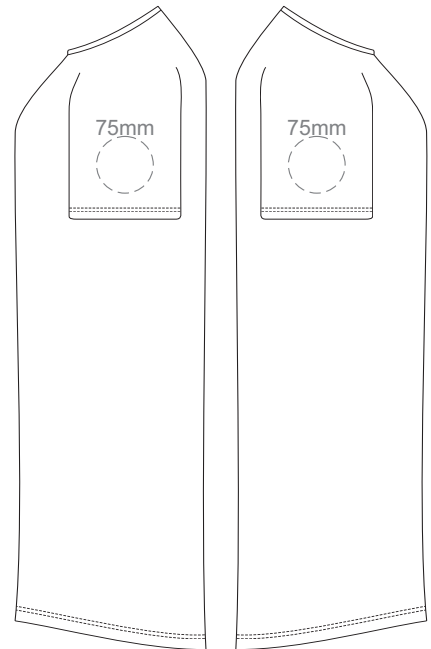

MEN'S 3XL LEFT SLEEVE

MEN'S 3XL RIGHT SLEEVE

MEN'S 3XL

